

SERIES 5 DENTAL CHAIR
Instructions For Use

OVERVIEW

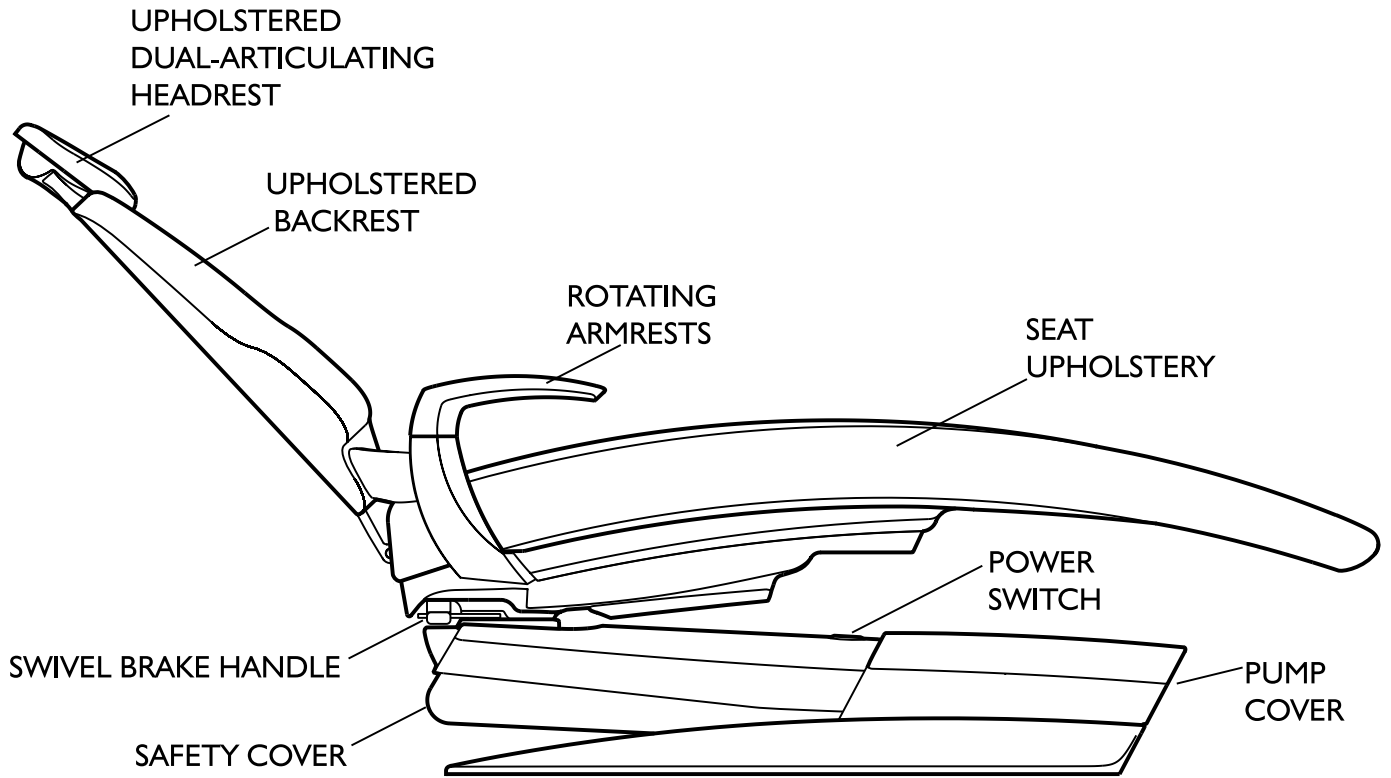

INTRODUCTION

SYMBOLS

The following symbols may be used throughout this product manual:





















-  **CAUTION:** General Caution. Failure to carefully follow the described procedure may result in damage to the equipment.
-  **WARNING:** Failure to carefully follow the described procedure may result in damage to the equipment, the operator, and/or the operator.
-  **ELECTRICAL HAZARD:** Risk of electrical shock present. Ensure that power is disconnected before attempting this procedure.
-  **NOTE:** Take note of additional important information. Not a warning or caution.
-  Manufacturer
-  Manufacturing date
-  Waste Electrical and Electronic Equipment
-  Type B Equipment (Protected against electrical shock)
-  Protective Earth (ground)
-  Alternating Current
-  Power OFF
-  Power ON
-  Conforms to applicable European Directives (Essential Requirements)
-  Electrical Testing Lab
-  Advisable to consult accompanying documents
-  Refer to instruction manual/booklet
-  Chair Function: directional movement key
- 0 1** Chair Function: Chair Preset position keys 0 and 1
-  Program key
-  Chair Function: Return to last position key
-  Swivel brake unlock symbols

TABLE OF CONTENTS

System Overview	2
Introduction	3
General Information	4
General Safety	5
Operation - Keypads & Headrest	6
Operation - Swivel	8
Operation - Safety Stops	9
Optional Quick Connection Box	10
Cleaning, Disinfection, Sterilization	12
Electromagnetic Compatibility	13

GENERAL INFORMATION

INTENDED APPLICATION AND USE

The DCI Edge dental patient chair is a device intended to position the patient in such a manner to provide to the dental practitioner visual and manual access to the oral cavity. This device should provide for the ergonomic necessities of most patients, both adults and children, throughout its range of movement. The device shall also be the means of supporting delivery systems for the purpose of standard dental procedures.

The dental chair is classified as Class I device under rule FDA CFR 21, Class I device under Health Canada guidelines, and a Class I device under rule 11 of the MDD 93/42/EEC of Annex VII.

PRODUCT IDENTIFICATION

The DCI Edge Series 5 Patient Chair can be identified by the label on the back side of the light head. This label states the model number, serial number, electrical specifications, manufacturing date, software version, and safety classifications.

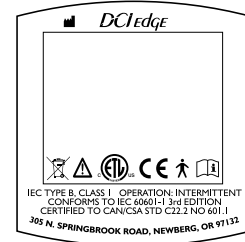

ELECTRICAL SPECIFICATIONS

115VAC	IEC Medical Classification I
8 Amps	TYPE: B Chair upholstery
50-60Hz	Operation: Continuous
	Duty Cycle: 20 Seconds ON, 5 Minutes OFF
	Splash Protection: IPX0 (FOOT SWITCH IPX1)
230VAC	
2.5 Amps	
50-60Hz	

ENVIRONMENTAL CONDITIONS

Operating Conditions:
Temperature: 67-76° F
Humidity: 20-60%
Altitude: <5,000 m

Shipping conditions:
Temperature: -68 - 122° F
Humidity: 10-90%

ELECTRICAL DEVICE INTERFERENCE

To guarantee the operational safety of electromedical devices, it is recommended that the operation of mobile radio telephones in the medical practice or hospital be prohibited. Strong EMI sources such as electro surgery units or x-ray units may effect performance. If performance problems occur, move the chair to another electrical circuit or physical location.

INCOMPATIBLE DEVICES

For safety reason, only DCI original devices and accessories approved for this product or accessories from third parties released by DCI may be used.

TECHNICAL DOCUMENTATION

The manufacturer will make available upon request circuit diagrams, component part lists, descriptions, and calibration instructions to technical personnel responsible for the installation and service of this equipment.

PRODUCT DISPOSAL

Contact your local, authorized dealer for disposal of this device to ensure compliance with your local environmental regulations.

PREVENTATIVE INSPECTION

The performance of the equipment can be affected by use over time. Periodically inspect the water and air lines for visible cracks or cuts and inspect for loose fittings and fasteners which could lead to leaks or other poor performance characteristics. Inspect joints and tensioning screws as a regular maintenance item to ensure proper positioning of the device.

GENERAL SAFETY

WARNINGS & CAUTIONS



WARNING: This product must be disinfected before use.



CAUTION: Only authorized service technicians should attempt to service this equipment. Use of other than authorized technicians will void the warranty.



CAUTION: Use a licensed electrician for all wiring.



WARNING: To avoid risk of electric shock, this equipment must be connected only to supply mains with protective ground.



WARNING: Modification of this equipment is not allowed.



WARNING: Failure to disinfect this device between patients could expose the user and patient to cross contamination and bio burden/biocontamination.



WARNING: Power cords and their associated parts cannot be substituted without increase risk of shock or fire. Use authorized replacement parts only. Power cords must be installed by qualified personnel. Ensure all service loops, strain reliefs and cord guards are in place and that line, neutral and ground wires are secured.



WARNING: Maximum load capacity is 350lbs. Do not exceed this limit. Doing so may cause personal injury and/or damage to the chair.



WARNING: To avoid possible injury and/or damage to the chair, do not apply full body weight on the headrest, backrest, toeboard and armrest. Doing so may cause the chair to tip.



WARNING: To isolate from mains power, unplug the cord. Make sure to leave the mains cord accessible.



WARNING: Press any key on footswitch or accessory control keypad to terminate motion of the chair while it is moving.



WARNING: Do not connect extension cords or power strips to the electrical receptacles optional Quick Connector Box.



WARNING: Do not allow children unsupervised access to the dental chair and auxiliary equipment.

This product is intended for use by trained dental/medical professional only.

OPERATION - FOOT SWITCH

CONTROLS

FOOT PAD

BACKREST INCLINE: Raise the backrest by pressing your foot toward the right of the foot pad.

BACKREST RECLINE: Recline the backrest by pressing your foot toward the left of the foot pad.

CHAIR UP: Raise the seat of the chair by pressing your foot toward the top of the foot pad.

CHAIR DOWN: Lower the seat of the chair by pressing your foot toward the bottom of the foot pad.

KEYS

RETURN: Press this key to return the chair to the previous position (the last position held for longer than 10 seconds). Press any key to cancel while in motion.

PRESET POSITIONS: Press "0" or "1" to activate preset positions. Press any key to cancel while in motion.

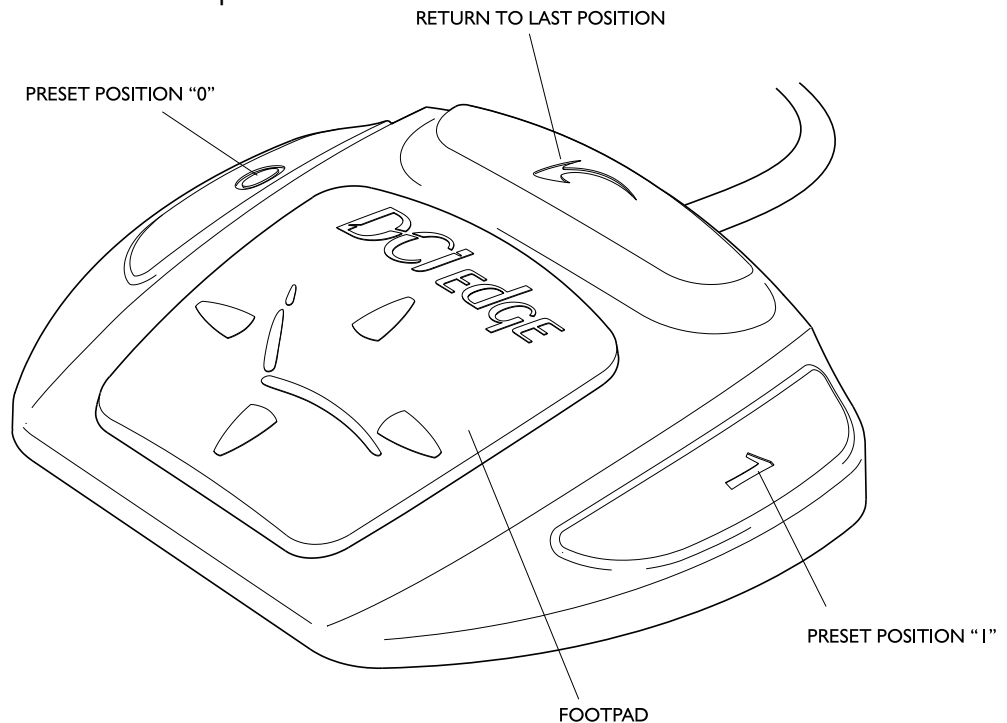

SETTING PRESET POSITIONS

ASSIGN POSITION TO "0" OR "1"

1 Adjust the position of the chair that you want to assign to a Preset Position key.

2 Press and hold "0" or "1" for five seconds. A long audible beep will sound to indicate that the assignment is complete.

OPERATION - HEADREST

DUAL ARTICULATING MECHANISM

Reposition the headrest by first supporting the back of the headrest with one hand and then depressing the lock release button on the right side of the headrest arm. Once the lock has been released, both pivot points will rotate freely and allow for adjusting both the elevation and the tilt of the headrest.

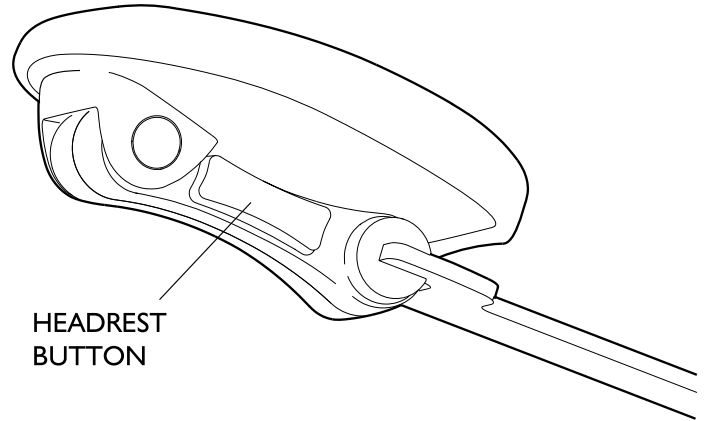

HEADREST
BUTTON

HEADREST BAR

REPOSITIONING

Reposition the height of the headrest so that it aligns to the patient's head by lifting up on the headrest. The tensioning mechanism on the headrest bar will allow the headrest to hold in position. Do not remove the headrest beyond the marked line on the headrest bar when a patient is seated.



WARNING: Removal of the headrest past the printed line could result in injury to the doctor or patient.

WARNING:
DO NOT REMOVE
PAST THIS LINE

TENSION ADJUSTMENT

Increase or decrease the tension on the headrest bar by using a hex wrench to tighten or loosen the tension screw beside the opening for the headrest bar at top of the backrest.

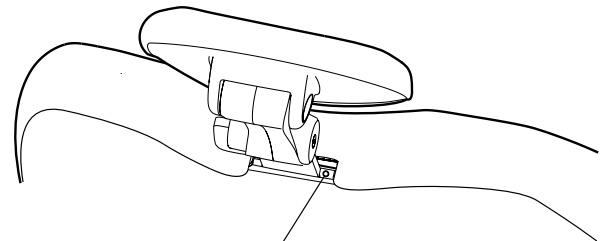

TENSION ADJUSTMENT SCREW

OPERATION - SWIVEL

SWIVEL ROTATION

The upper half of the chair swivels 30 degrees to each side of the centerline of the chair for the purpose of maximizing space in the operatory and gaining better access to the oral cavity.

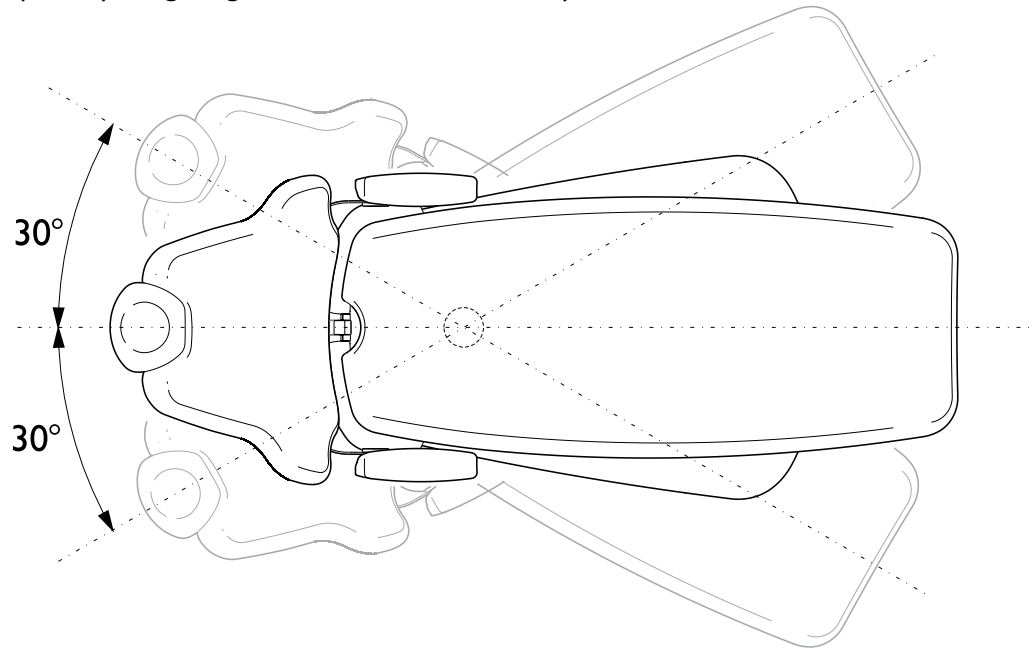

SWIVEL BRAKE HANDLE

Rotate the upper half of the chair by releasing the swivel brake handle accessed at the rear of the chair. Lock the position by returning the handle to the original position.

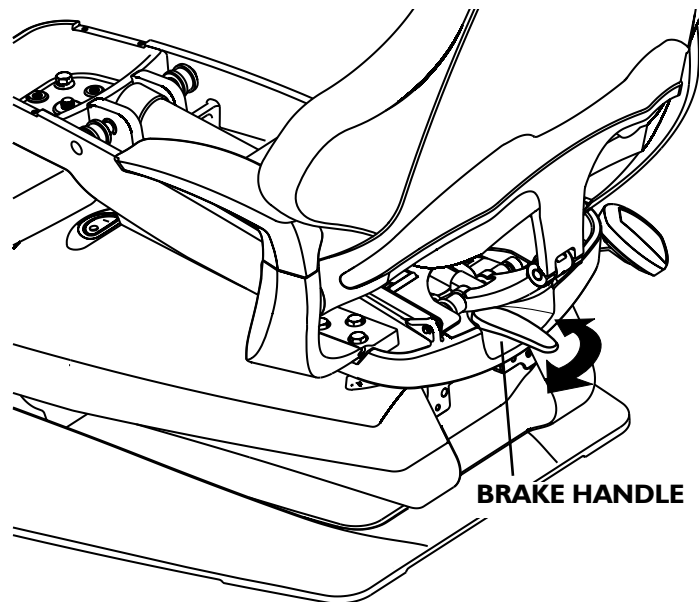

OPERATION - SAFETY STOPS

SAFETY STOP

Downward motion is stopped in the event that the underside of the truss impacts an obstruction during its downward travel. The Safety Cover located on the bottom side of the truss is designed to shift and engage safety switches located on the either side of the truss. While the safety switches are engaged, downward travel of the chair is disabled for the purpose of safety.

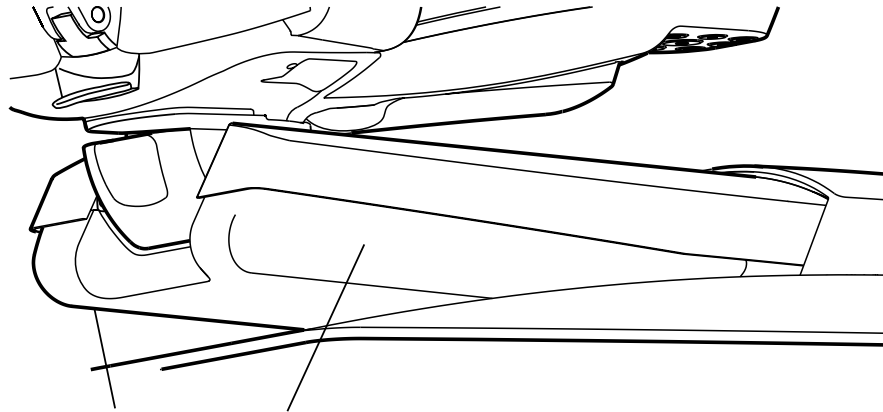

SAFETY SWITCHES BEHIND COVER

FOOT CONTROL ACTIVATED LOCKOUT

When configured in combination with a Series 5 delivery system, chair movement is disabled when the foot control is pressed. When the foot control is not actively being pressed, chair movement returns to normal functionality.

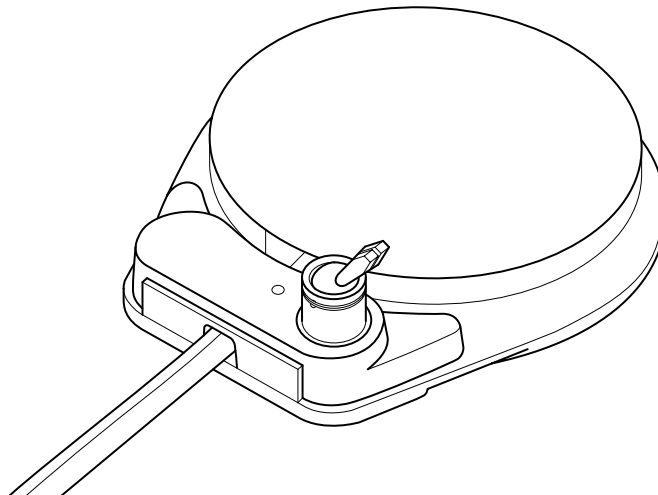

OPTIONAL QUICK CONNECTION BOX

ELECTRICAL OUTLETS

The optional quick connection box is conveniently located underneath the seat, providing air and water outlets and a duplex electrical outlet. These outlets can accommodate extra auxiliary equipment that is within the user's reach.

The electrical outlet is rated at a maximum of 1.5 amp. per receptacle. If the 3 amp circuit breaker should open, reset it by pressing the reset button.



WARNING: Do not connect extension cords or power strips to the electrical receptacle's optional Quick Connection Box.

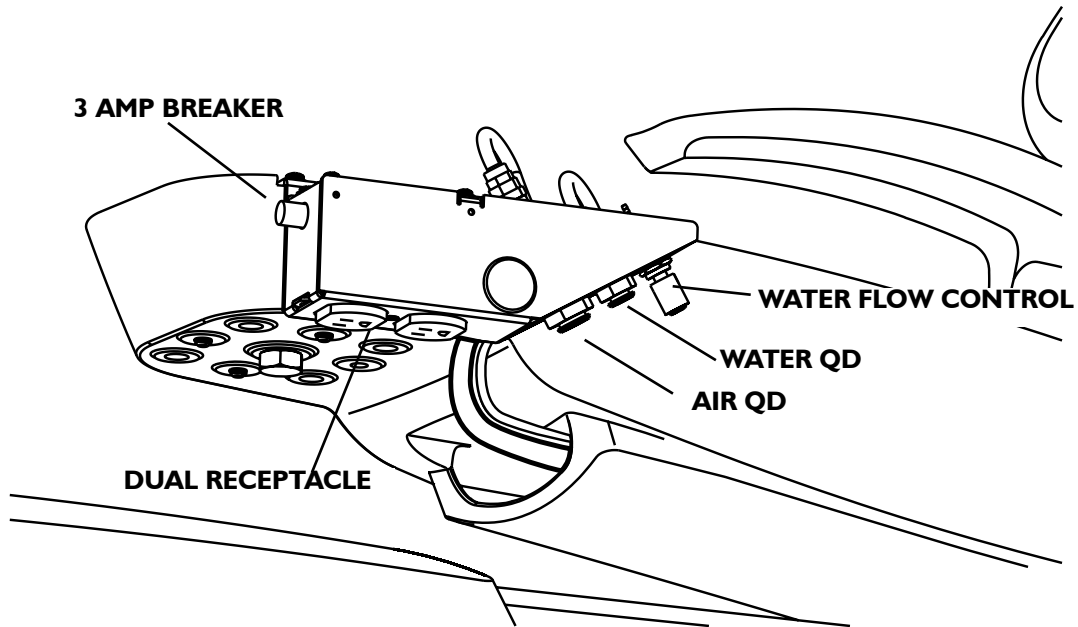

AIR AND WATER CONNECTIONS

The water outlet accepts 1/4" QD fitting and has an integral shut-off valve. Next to the water outlet is a control valve to adjust flow from the water outlet. The air outlet accepts a 3/8" QD fitting and has an integral shut-off valve.

CLEANING, DISINFECTION AND STERILIZATION

BARRIER TECHNIQUE

Wherever possible, use disposable barriers and change them between patients. The barrier technique will ensure maximum long term durability of the surfaces and finishes of the equipment.

DISINFECTION & STERILIZATION

The Manufacturer will not attempt to specify the required intervals for disinfection nor can it recommend the overall best surface disinfectant. Please refer to the Infection Control Recommendations published by the American Dental Association for further information.

The use of chemical disinfecting agents is not necessary if the instrument is going to be sterilized. While their use may be easy and quick, it is important to know the effectiveness of any chemical disinfectant against the various agents of infection that may be encountered.

CHEMICAL DISINFECTION

Follow the instructions below carefully to ensure the longest life for your equipment:

1. Only use the acceptable disinfectants listed. Use of unacceptable products will void your warranty.
2. Thoroughly wash all areas that have been exposed to disinfectant cleaners with mild soap and warm water at least once per day. This wash down will minimize the harmful effects of chemical disinfectant residues being allowed to accumulate on the equipment.
3. When using chemical disinfectants, always pay strict attention to the manufacturer's disinfectant directions.
4. When using concentrated disinfectants, measure the concentrate carefully and mix according to package directions.
5. Disinfectant solutions that are relatively harmless to surfaces at their recommended strengths can be corrosive at higher than recommended dilution ratios.

Conditionally Acceptable Disinfectants

Phthalaldehyde
Quarternary Ammonium
Glutaraldehyde



CAUTION: These disinfectants will harm the surface finish of dental equipment and are not recommended.

Unacceptable:

Strong Phenols/Phenol Alcohol combinations
Sodium Hypochlorite/Household Bleach
Sodium Bromide
Strong Alcohol
Household Cleaners (Dental Equipment Only)
Citric Acids
Iodophors
Ammonium Chloride
Accelerated Hydrogen (0.5%).

STERILIZATION

There are several methods of sterilization that may be used. It is important to remember, however, that regardless of the method you choose, temperatures should never exceed 275° Fahrenheit (135° Celsius). Any of the following sterilization methods may be safely used on your autoclavable instruments:

- Steam Autoclave
- Ethylene Oxide Gas
- Chemical Vapor Process

Do not allow the instruments to come into contact with the walls of the sterilizer. Avoid placing the instruments in close proximity to the sterilizer heating element. Dry heat sterilization is not recommended because of the difficulty in maintaining the precise temperature control necessary to prevent damage to the instruments.



CAUTION: When using the chemical vapor process, it is essential to rinse out all cleaning agents with clear water. The internal surfaces and passages must be thoroughly purged of residual cleaning agents by flushing with water then isopropyl alcohol. This will prevent the formation of a crystalline residue resulting from reactions between the chemical vapor solutions and cleaning agents.

CLEANING, DISINFECTION AND STERILIZATION

GENERAL CLEANING

Equipment can be cleaned with a solution of mild detergent and warm water. A variety of surface disinfectants are available for use in dental treatment rooms. Some of these can cause discoloration of painted, plated or anodized surfaces with repeated use. This can be minimized by careful adherence to the disinfectant manufacturer's instructions and by frequent washing with soap and water.



CAUTION: Do not use powdered cleansers, scouring pads or abrasive scrubbers on any of the painted, plastic or metal surfaces of this dental unit. To remove dried-on material, use a soft-bristled brush and a solution of mild detergent.

CLEANING UPHOLSTERY



WARNING: In order to mitigate the risk of cross-contamination between patients, disinfection and sterilization of handpieces **must occur after each dental procedure**. Refer to the handpiece manufacturer's instructions and recommendations for sterilization or disinfection procedure.

NORMAL CLEANING

Mix a solution of 10 percent liquid dish soap with warm water and apply to the upholstery with a soft, damp cloth. Rinse with clean water and wipe dry. Cleaning frequency depends upon use. It is recommended that upholstery be cleaned between patients.

STAINS

Stubborn Stains

Use detergent cleaners such as Formula 409 or Fantastik. Wipe using a soft cloth or bristle brush. Rinse with clean water and wipe dry.

More Difficult Stains

Carefully clean the stained area with lighter fluid (naphtha) or rubbing alcohol. Apply with a soft white cloth and rub gently. Rinse with clean water and wipe dry.

OTHER TIPS

Always apply cleaners with a soft white cloth. Avoid the use of paper towels. When using strong cleaning solutions such as alcohol, it is advisable to first test in an inconspicuous area. Never use harsh solvents or cleaners that are intended for industrial use. To restore luster, a light coat of spray furniture wax may be used. Apply to chair and allow to set for 30 seconds. Lightly buff dry with a clean, dry cloth.

ELECTROMAGNETIC COMPATIBILITY

DEVICE COMPATIBILITY

ELECTRICAL MEDICAL

Electrical medical devices are subject to special EMC safety measurements and as a result the equipment must be installed according to the installation instruction manual.

PORTABLE ELECTRONIC DEVICES

Portable and mobile high frequency electronic communications equipment may interfere with electronic medical devices.

STATIC SENSITIVE DEVICES

Where labeled this equipment contains static sensitive devices that require special precautions when handling. At a minimum a grounded wrist strap that is connected to a ground stud should be worn to reduce the possibility of damage.

ACCESSORY USE

Using accessory devices not specified by DCI for use with their equipment may result in an increase of electromagnetic emissions and/or a decrease in electromagnetic immunity of the system.

INTERFERENCE FROM OTHER EQUIPMENT

If other equipment is used adjacent to or stacked with the DCI Edge equipment, the system must be observed to verify normal operation.

DCI EDGE EQUIPMENT COMPLIANCE

This equipment has been tested and found to comply with the limits for medical devices in IEC 60601-1-2. These limits are designed to provide reasonable protection against harmful interference in a typical medical installation. In the event of interference, power the devices from separate mains supplies and/or increase the physical distance between devices. Contact Customer Service if you have any questions.

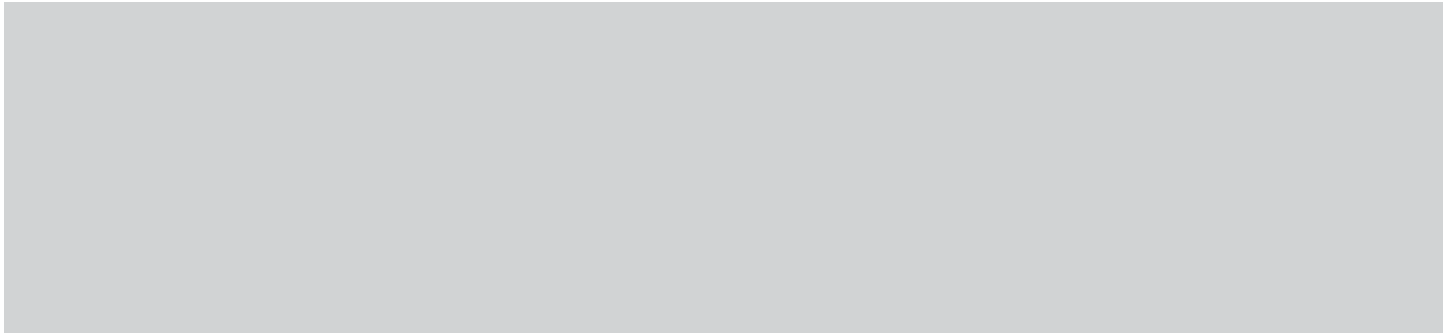

CE

PN 50050, Rev. A, 04/16

www.dcionline.com
800-624-2793

***DCI* edge**

305 N. Springbrook Road
Newberg, OR 97132, USA